

Q-5 Turbo

USER MANUAL

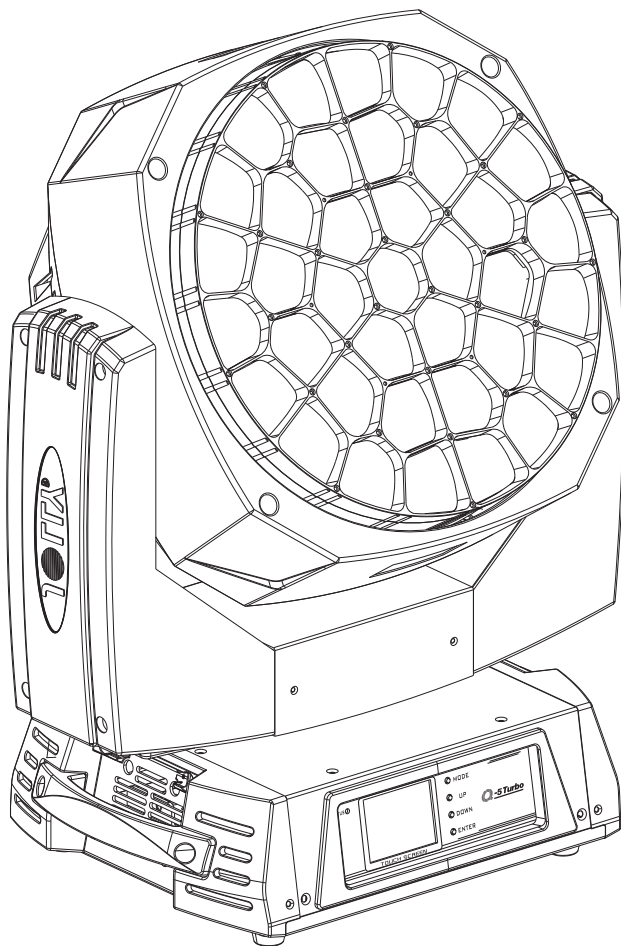

CE

JOLLY®

Table of content

1.Open–Package guidelines.....	1
1. 1 Package.....	1
2.Safety instructions.....	1
3.Operating determination.....	3
4.Rigging the fixture.....	4
4.1 Mounting.....	4
4.2Installing the Clamps.....	4
4.3 Power supply connection and cut off.....	5
4.4 Power Connection.....	6
4.5 DMX–512 connection/connection between fixtures.....	6
5.Description of the device.....	7
6.Dimension.....	8
7.Display control.....	9
7.1 Navigation in the Menu.....	9
7.2 Display Operation.....	9
7.3 Unit Menu(A mode)	11
7.4 Multivariable Menu(B mode)	12
8.DMX protocol.....	13
8.1 Unit model(A mode).....	13
8.2 Multivariable model(B mode).....	22
9.Maintance and cleaning.....	26
10.Electric equipment specification.....	26
10.1 Electrical paramters.....	26
10.2 Weight and dimensions.....	26
10.3 Channel Characteristics.....	26
10.4 Menu Function.....	27
10.5 light table.....	27
11.Electronic drawing.....	31

Congratulations on choosing our products! Please carefully read this instruction manual in its entirety and keep it well for using reference. This manual contained about the installation and the relative using information of this products. Please refer to this manual's relative instruction when using this equipment.

1. Open-Package guidelines

This equipment is made of new style, high intensity plastic. It fully shows the modern times light characteristic with beauty structure. And it is made according to CE standard. Fully agree with the international standard of DMX512 agreement.

When receive the product, please be careful to take and put, check if the product has damage or not because of transportation, and check the following parts:

- | | |
|---------------------|----------------------|
| 1. Signal cable-1PC | 2. Safty cable-1PC |
| 3. User Manual-1PC | 4. Omega holder-2PCS |
| 5. Power cable-1PC | 5. Service card-1PC |

1.1 Package

Unpacking the fixture

1. Open the flight case cover
2. With one person on each side, lift the fixture out of the flight case.
3. Unlock pan and tilt before operating fixture

Packing the fixture

1. Disconnect the fixture from power and allow it to cool.
2. Lock arms as figure.- Fig.1(PAN Mechanism Lock and Release (every 90°) - Fig.2)
3. Place the fixture in the bottom of the flight case, and cover the case without forcing.

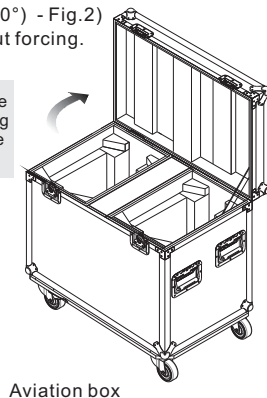
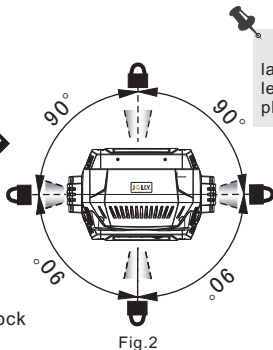
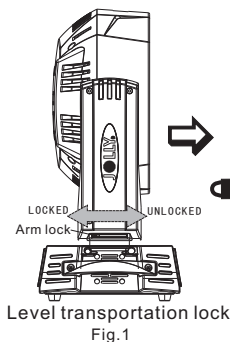

2. Safety instructions

Every person involved with installation and maintenance of this device to:

- Be qualified
- Follow the instructions of this manual.

CAUTION!

*Be careful with your operations.
With a high voltage you can suffer
a dangerous electric shock when touching the wires!*

This device has been shipped with our premises in absolutely perfect condition. In order to maintain this condition and to ensure a safe operation, it is absolutely necessary for the user to follow the safety instructions and warning notes written in this manual.











Important:

- The manufacturer will not accept liability for any resulting damages caused by the nonobservance of this manual or any unauthorized modification to the device.
- Please consider that damages caused by manual modifications to the device are not subject to warranty.

- Never let the power-cord come into contact with other cables! Handle the power cord and all connections with particular caution!
- Make sure that the available voltage is not higher than stated on the rearpanel.
- Always plug in the power plug least. Make suer that the power-switch is set to off-position before you conctions with themains with particular caution!
- Make sure that the power-cord is never crimped or damaged by sharp edges.Check the decice and the p-ower-cord from time to time.
- Always disconnect from the mains, when the device is not in use or before cleaning it.
- Only handle the power-cord by the plug, Never pull out the plug by tugging the powercord.
- This device falls under protection class I. Therefore it is essential to connect the yellow/green conductor to earth.
- The electric connection, repairs and servicing must be carried out by a qualified employee.
- Do not connect this device to a dimmer pack.
- Do not switch the fixture on and off in short intervals as this would reduce the lamp's life.
- Do not touch the device's housing bare hands during its operation(housing becomes hot)!
- For replacement use lamps and fuses of same type and rating only.

Eye damage!

Avoid looking directly into the light source(meant especially for epileptics)!

- 
 ➤ Minimum distance of illuminated objects
 The projector needs to be positioned so that the objects hit by the beam of light are at least 0.20 metres from the lens of the projector.
- 
 ➤ Maximum ambient temperature
 Do not operate the fixture if the ambient temperatuer (Ta) exceeds 40°C (104°F).
- 
 ➤ Temperature of the external surface
 The maximum temperature that can be reached on the external surface of the fitting, in a thermally steadystate, is 90°C (194°F).
- 
 ➤ IP20 protection rating
 The fitting is protected against penetration by solid of over 12mm (0.47") in diameter (first digit 2), but not against dripping water, rain, splashes or jets of water (second digit 0).
- 
 ➤ Indoor use only
- 
 ➤ Not suitable for household illumination
- 
 ➤ Photobiological Safety
 CAUTION. Possibly hazardous optical radiation emitted from this product. Do not stare at operating lamp. May be harmful to the eyes.
- 
 ➤ Light collimation system
 This product contains internal light collimation system. Avoid intense light from any angle.
- 
 ➤ The products to which this manual refers comply with the European Directives pursuant to:
 - 2006/95/EC - Safety of electrical equipment supplied at low voltage (LVD)
 - 2004/108/EC - Electromagnetic Compatibility (EMC)
 - 2011/65/EU - Restriction of the use of certain hazardous substances (RoHS)
 - 2009/125/EC - EcoDesign requirements for Energy-related Products (ErP)
- 
 ➤ Protection against electrical shock
 Connection must be made to a power supply system fitted with efficient earthing (Class I appliance according to standard EN 60598-1). It is, moreover, recommended to protect the supply lines of the projectors from indirect contact and/or shorting to earth by using appropriately sized residual current devices.



➤ Disposing

This product is supplied in compliance with European Directive 2012/19/EU-Waste Electrical and Electronic Equipment (WEEE) .To preserve the environment please dispose/recycle this product at the end of its life according to the local regulation.



➤ Battery

This product contains a rechargeable lead-acid or lithium iron tetraphosphate battery. To preserve the environment, please dispose the battery at the end of its life according to the regulation in force.

3. Operating determinations

- This device is a moving-head for creating decorative effects and was designed for indoor use only.
- If the device has been exposed to drastic temperature fluctuation (e.g. after transportation), do not switch it on immediately. The arising condensation water might damage your device. Leave the device switched off until it has reached room temperature.
- Never run the device without lamp!
- Do not shake the device, Avoid brute force when installing or operating the device.
- Never lift the fixture by holding it at the projectorhead, as the mechanics may be damaged. Always hold the fixture at the transport handles.
- When choosing the installation-spot, please make sure that the device is not exposed to heat, moisture or dust. There should not be any cables lying around. You endanger your own and the safety of others!
- The minimum distance between light output and the illuminated surface must be more than 0.2 meters.
- Make sure that the area below the installation place is blocked when rigging, derigging or servicing the fixture.
- Always fix the fixture with an appropriate safety rope, Fix the safety rope at the correct holes only.
- Operate the fixture after having checked that the housing is firmly closed and all screws are tightly fastened.
- The lamp must never be ignited if the objective-lens or any housing-cover is open, as discharge lamps may explode and emit a high ultraviolet radiat, which may cause burns.
- The maximum ambient temperature 40° C must never be exceeded.
- Operate the device only after having familiarized with its functions. Do not permit operation by persons not qualified for operating the device. Most damages are the result of unprofessional operation!
- Please use the original packaging if the device is to be transported.
- Please consider that unauthorized modifications on the device are forbidden due to safety reasons!
- If this device will be operated in any way different to the one described in this manual, the product may suffer damages and the guarantee becomes void. Furthermore, any other operation may lead to dangers like short-circuit, burns, electric shock, burns due to ultraviolet radiation, lamp explosion, crash etc.

4. Rigging the fixture

4.1 Mounting



Pay attention to the regulations of CE.

Installation by qualified staff to complete.

- ☞ For the various mounting positions of the FIXTURE (standing on the floor, sideways or hanging) different accessories kits are available.
- ☞ Through this a safe and firm installation is assured.
- ☞ You'll find special connectors on the bottom side of the system which are put to use here.

4.2 Installing the Clamps

Please consider the respective national norms during the installation! The installation must only be carried out by an authorized dealer!

The installation of the projector has to be built and constructed in a way that it can hold 10 times the weight for 1 hour without any harming deformation.

The installation must always be secured with a secondary safety attachment, e.g. an appropriate catch net. This secondary safety attachment must be constructed in a way that no part of the installation can fall if the main attachment fails.

When servicing the fixture staying in the area below the installation place, on bridges, under high working places and other endangered areas is forbidden.

The operator has to make sure that safety-relating and machine-technical installations are approved by an expert before taking into operation for the first time and after changes before taking into operation another time.

The operator has to make sure that safety-relating and machine-technical installations are approved by an expert after every four year in the course of an acceptance test.

The operator has to make sure that safety-relating and machine-technical installations are approved by a skilled person once a year.

The projector should be installed outside areas where persons may walk by or be seated.

Important! Overhead rigging requires extensive experience CE, including (but not limited to) calculating working load limits, installation material being used, and periodic safety inspection of all installation material and the projector. If you lack these qualifications, do not attempt the installation yourself, but instead use a professional structural rigger. Improper installation can result in bodily injury and or damage to property.

The projector has to be installed out of the reach of people.

If the projector shall be lowered from the ceiling or high joists, professional trussing systems have to be used. The projector must never be fixed swinging freely in the room.

Caution Projectors may cause severe injuries when crashing down! If you have doubts concerning the safety of a possible installation, do not install the projector!

Before rigging make sure that the installation area can hold a minimum point load of 10 times the projector's weight.

The projector can be placed directly on the stage floor or rigged in any orientation on a truss without altering its operation characteristics.

For overhead use, always install a safety-rope that can hold at least 10 times the weight of the fixture. You must only use safety-ropes with screw-on carabines. Pull the safety-rope through the two apertures on the bottom of the base and over the trussing system etc.

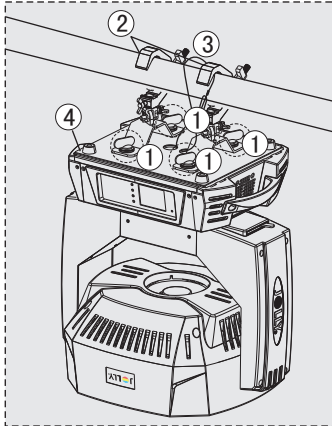

Warning: it is necessary to make sure that the installation location is perfectly appropriate, and the installation location is safe and reliable.

- ① Lock catch
- ② Omega holder
- ③ Secure chain
- ④ Mounting plate

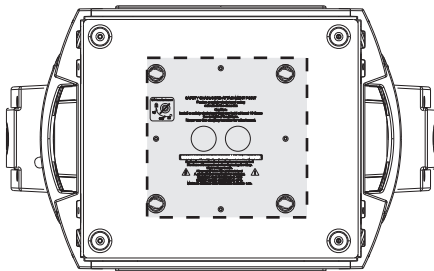

1/4 turn fasteners

SAFETY CHAIN/CORD ATTACHMENT POINT

Fasten a safety chain/cord using cutouts in the chassis!

Caution:
Install a safety chain/cord that can hold at least 10 times the weight of the fixture.
Never use the carrying handles for attachment.

DISCONNECT SUPPLY BEFORE REMOVING ANY COVER

During the operation the housing becomes very hot!
Disconnect from mains before replacing the lamp.
High voltage inside.

Keep away from rain and moisture!
Maximum room temperature: 40°C
Exterior surface temperature: 60°C.
Minimum distance from flammable material: 0.8m.

4.3 Power supply connection and cut off

Connect the light source to the main power source with the plug of the power cord, or cut off the power supply:

Connection: according to procedures, the power plug and socket is inserted into the groove one one alignment, rotation.

Cut off: according to procedures, press the button on the rotating plug, pull out.

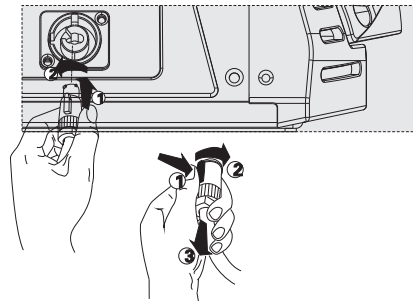

4.4 Power Connection

If you wish to change the power supply settings, see the chapter appendix Connect the fixture to the mains with the enclosed power cable and plug.



Warning: please verify the power of the power supply equipment prior to the connection! Earth wire must be grounded!

CABLE(EU)	CABLE(US)	Pin	INTERNATIONAL
Brown	Black	Live	L
Light blue	White	Neutral	N
Yellow/Green	Green	Earth	

4.5 DMX-512 connection/connection between fixtures

Only use stereo shielded cable and 3-pin XLR-plugs and connectors in order to connect.

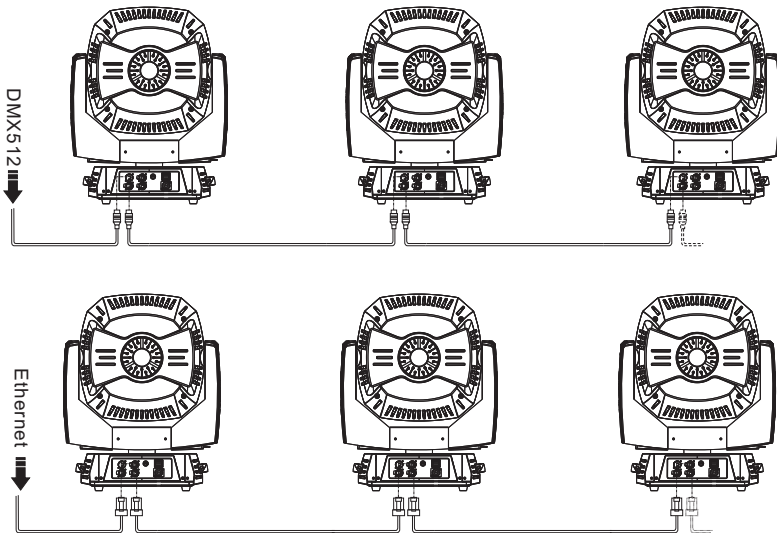

Caution

At the last fixture, the DMX-cable has to be terminated with a terminator. solder a 120 resistor between signal(-) and Signal (+) into a 3-pin XLR-plug and plug it in the DMX-output of the last fixture.

DMX output 3-pin XLR socket DMX input 3-pin XLR socket

DMX output 5-pin XLR socket DMX input 5-pin XLR socket



- 1: Ground
- 2: Signal (-)
- 3: Signal (+)



- 1: Ground
- 2: Signal (-)
- 3: Signal (+)
- 4: N. A.
- 5: N. A.

DMX Terminator Diagram

-For installations where the DMX cable has to run a long distance or is in an electrically noisy environment it is recommended to use a DMX terminator. This helps in preventing corruption of the signal by electrical noise. The DMX terminator is simply an XLR plug with a 120Ω resistor connected between pins 2 and pins 3, which is then plugged into the output XLR socket of the last fixture in the chain.

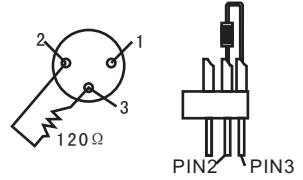

5. Description of the device

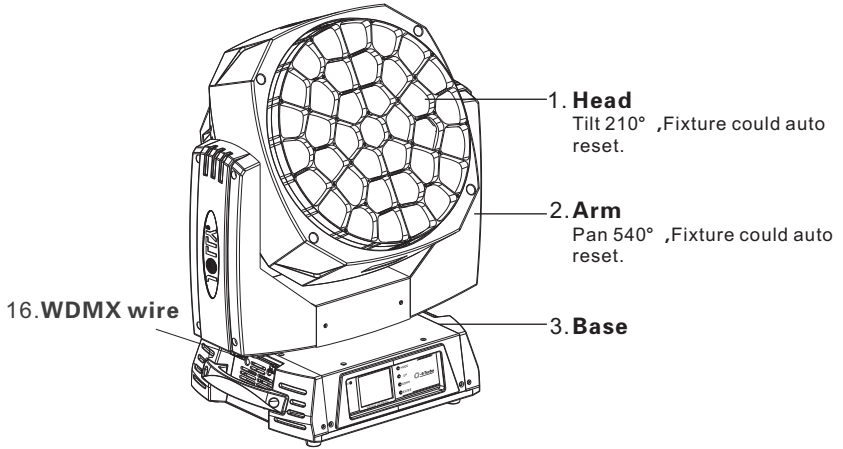

BACK PANEL

- 4. 5-pin XLR female
- 5. Network interface
- 6. Power-in
- 7. Power switch
- 8. Main Fuse
- 9. 5-pin XLR male

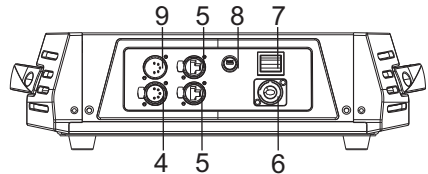

CONTROL PANEL

- 10. Status indicator lamp
- 11. Touch screen (LCD display)
- 12. MODE button
- 13. UP button
- 14. DOWN button
- 15. ENTER button
- 16. WDMX Wire

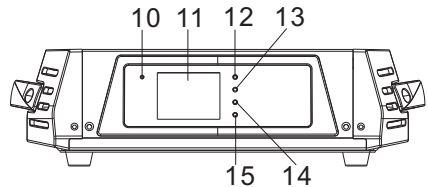

6.Dimension

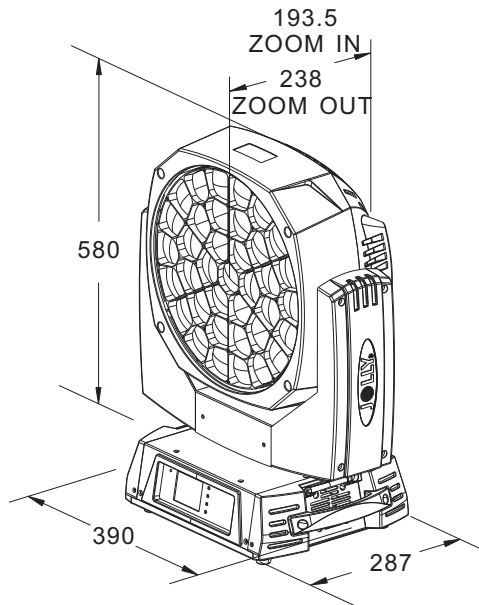
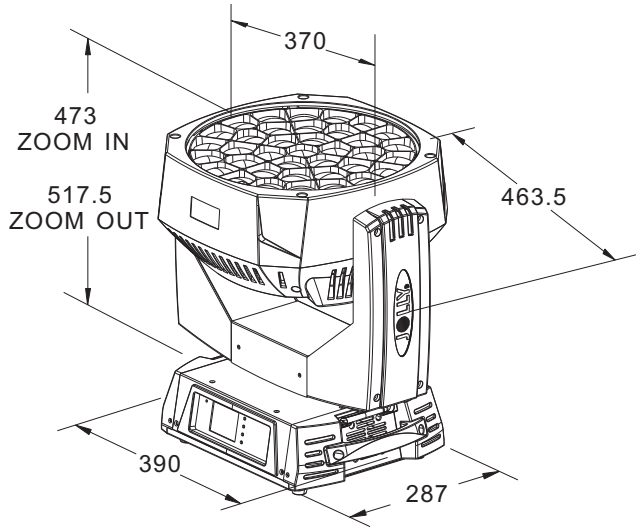

7. Display control

7.1 Navigation in the Menu

Using the buttons or touch screen, and this can be simply and easily set the address code and functions code.

If you view or modify the lighting feature set, then press ENTER button, the display will enter the menu interface. Both there is sub menu corresponding to the functional operation of the main menu. Each of the menus is representative of the specific features of the lamp. The specific contents shows as the table menu below.

Set or browse lighting function, press UP or DOWN button.

Press ENTER to save your changes or enter the submenu. Press the UP or DOWN can change the numerical (increase or decrease in value).

Press the MODE button to return to menu. Set a time 0 to 10 minutes automatically exit menu interface and close the screen.

7.2 Display Operation

Put through power supply, open the power switch of lamps and lanterns, display show the company LOGO website. According to the main interface, as shown in figure:

In the main interface, press "MODE" button to view the software version, press the "UP" "DOWN" can modify the DMX address.

If the screen "⊙" icon is green, said DMX signal connection is normal, this state can be used to check the lamps and lanterns and connection between the control table is normal.

This lamp contains "A" and "B" two control modes are optional, see below; (A mode, also known as unit mode, its function as a network and only a single control console. B mode known as multivariate models, its function as a network and control console merge or separate two options.)

The screenshot shows the main interface of the lamp's control system. At the top, there is an 'Input password' field set to '0000'. Below it are four control panels: 'DMX ART-NET' (with Standard, Shapes, Extended, Extended Rgbw, Full options), 'Channel Mode' (with Standard, Shapes, Extended, Extended Rgbw, Full options), 'Dmx Input' (with Wired Input, Wireless Input, Wireless In/XLR out, Ethernet Input options), and a 'Basic' vs 'ART-NET' selection. The main display area shows '001', 'A', '1', and a green '⊙' icon. A 'Main interface 1' is displayed with a '1' and a '⊙' icon. A 'Settings' button is at the bottom with '001-021'. A 'Dmx Address' field shows '001'. A status panel on the left lists error codes (E12: BusErr1 01, E15: Ballast Error 07, E17: BD1 BUS Error 99, E18: BD2 BUS Error 99, E19: BD3 BUS Error 99). A 'Set Up' menu is on the left with options: Set Up, Information, Personality, Manual Control, Advanced. A 'Can view the company LOGO, web site, hardware, software version, date' note is at the bottom left. A 'CH-001 Red 000.0% 000', 'CH-002 Red Fine 000.0% 000', 'CH-003 Green 000.0% 000', 'CH-004 Green Fine 000.0% 000', 'CH-005 Blue 000.0% 000', 'CH-006 Blue Fine 000.0% 000', 'CH-007 White 000.0% 000', 'CH-008 White Fine 000.0% 000', 'CH-009 Linear CTO 000.0% 000', 'CH-010 Mono Colour 000.0% 000' panel is on the right. A note says 'press this area for 2 seconds to modify the DMX address.' pointing to the '1' and '⊙' icon.

A mode menu interface

This lamp can be set to turn off the automatic flip screen function, touch this "⊙" icon can be manually flip screen.

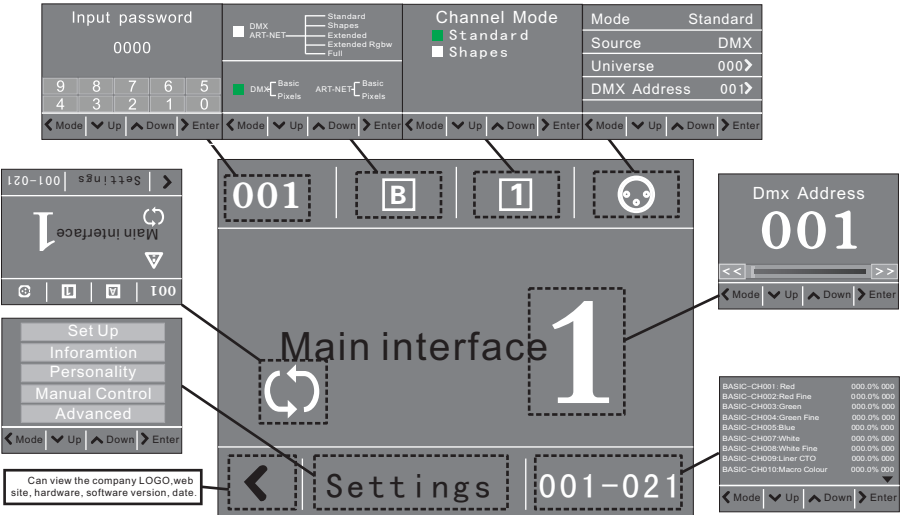

B mode menu interface

Click on the main interface of the icon, numerical to view view Settings related information of lamps and lanterns. Symbols such as the main interface appear "△", the following error message indicates that there might be a lamps and lanterns, can click to view and control information content to modify the lamps and lanterns.

CODE	ERROR MESSAGE	MEANS	REMARK
E02	Program Err 1	Check chip	Reset initialization error
E04	MBDInit Error	Check the master chip EP3C	
E05	BD1Init Error	Check the signal 485 and 485 chips, dialing, memory chips	
E06	BD2Init Error		
E12	BusErr1	Check ABAB Bus (485 chips)	
E16	MFpga Error	Check the display board master control chip is empty or false soldering	
E17	BD1 BUS Error	Look for virtual communication signal lines, communication chip welding or short circuit	
E18	BD2 BUS Error		
E21	Pan FB. Err	Check that the light coupling line, optical coupling switch and a plate of the relative position measurement	
E22	Pan Zero Err	Check line magnetic susceptibility, magnets and magnetic susceptibility of distance and location, have the magnet.	
E23	Tilt FB. Err	Check that the light coupling line, optical coupling switch and a plate of the relative position measurement	
E24	Tilt Zero Err	Check line magnetic susceptibility, magnets and magnetic susceptibility of distance and location, have the magnet.	
E36	Zoom RT. Error	Check line magnetic susceptibility, magnets and magnetic susceptibility of distance and location, have the magnet.	
E42	B.Fan1Error	Check the chassis fan is working properly	
E42	B.Fan2Error	Check the chassis fan is working properly	
E46	H.Fan Error	Check handpiece LED radiator fan is working	
E057	EthMDL Error	Check the Ethernet module and the communication lines are working properly	

7.3 Unit Menu(A mode)

Set up	DMX Address	Un iverse DMX Address 001~XXX
	Channel Mode	STANDARD 1~21
		SHAPES 1~35
		EXTENDED 1~132
		EXTENDED RGBW 1~169
		FULL 1~146
	Fixture Id	0001~XXXX
Multi Mode (use it under the module with art-net)	DMX ART-NET DMX+ART-NET	
Ethernet (use it under the module with art-net)	IPAddress Netmask	
Information	Fixture Times	XXXXX h XX m
	LED Timeshare	LED On Times XXXXh XXm Reset LED Time
	Error List	
	Diagnosis	BOARD 1: XX.XX% BOARD 2: XX.XX%
	DMX Values	
Personality	Pan/Tilt	Pan Reverse ON/OFF
		Tilt Reverse ON/OFF
		Feedback ON/OFF
	Dmx Input	Wired Input
		Wireless Input
		Wireless In/XLR out
	Screen	Ethnet Input (use it under the module with art-net)
Brightness		
Screen Time out 0~10m		
Touch Screen ON/OFF		
Manusl Control	Reset	Auto Screen ON/OFF
		Reset ALL
		Reset Pan/Tilt
Channel	Reset Other	
Advanced	Calibration	
	Factory Default	
	Touch Calibration	

7.4 Multivariable Menu(B mode)

Set up	Basi Engine	Mode	Standard
		Source	Shape
		Universe	DMX
		DMX Address	ART-NET
	Pixels Engine	Mode	001-XXX
		Source	001-XXX
		Universe	Disadied
		DMX Address	RGB
	Fixture Id	0001-XXXX	RGBW
	Multi Mode (use it under the module with art-net)	DMX ART-NET	DMX
		DMX+ART-NET	ART-NET
	Ethernet (use it under the module with art-net)	IP Address	001-XXX
		Netmask	001-XXX
		Confirm	
Information	Fixture Times	XXXXX h XX m	XXX.XXX.XXX.XXX
	LED Timeshare	LED On Times XXXXh XXm	Confirm
	Error List	Reset LED Time	XXX.XXX.XXX.XXX
	Diagnosis	BOARD 1: XX.XX%	Confirm
	DMX Values	BOARD 2: XX.XX%	Confirm
Personality	Pan/Tilt	Pan Reverse ON/OFF	
		Tilt Reverse ON/OFF	
	Dmx Input	Feedback ON/OFF	
		Wired Input	
		Wireless Input	
		Wireless In/XLR out	
	Screen	Ethnet Input (use it under the module with art-net)	
Brightness			
Screen Time out 0-10m			
Manusl Control	Reset	Touch Screen ON/OFF	
		Auto Screen ON/OFF	
		Reset ALL	
Advanced	Channel	Reset Pan/Tilt	
		Reset Other	
	Calibration		
Factory Default			
Touch Calibration			

8.DMX protocol

8.1 Unit model(A mode)

MODE1	MODE2	MODE3	MODE4	MODE5	CHANNEL NAME	CHANNEL FUNCTION	DMX VALUE
1	1	1	1	1	LED Red	back→Red 0–100%	0–255
2	2	2	2	2	Red fine	Red fine	0–255
3	3	3	3	3	LED Green	back→Green 0–100%	0–255
4	4	4	4	4	Green fine	Green fine	0–255
5	5	5	5	5	LED Blue	back→Blue 0–100%	0–255
6	6	6	6	6	Blue fine	Blue fine	0–255
7	7	7	7	7	LED White	back→White 0–100%	0–255
8	8	8	8	8	White fine	White fine	0–255
9	9	9	9	9	Linear CTO	Activation of the following functions LED white channel automatically shut down	
						Reserved	0–9
						8000K	10
						7000K	54
						6000K	99
						5600K	117
						5000K	144
						4000K	188
						3200K	224
2500K	255						
10	10	10	10	10	Macro colour	Reserved	0–9
						Red	10
						Green	11
						Blue	12
						Cyan	13
						Yellow	14
						Magenta	15
						White 7000 K	16
						White 3700 K	17
						White 5000 K	18
						Black	19
						Medium Yellow	20–22
						Straw Tint	23–26
						Surprise Peach	27–28
						Fire	29
						Medium Amber	30
						Gold Amber	31
Dark Amber	32–34						
Sunrise Red	35–44						
Medium Pink	45						
Medium Pink	46–48						
Pink Carnation	49–61						
Light Lavender	62–67						

MODE1	MODE2	MODE3	MODE4	MODE5	CHANNEL NAME	CHANNEL FUNCTION	DMX VALUE
10	10	10	10	10	Macro colour	Lavender	68-77
						Sky Blue	78-88
						Just Blue	89-99
						Dark yellow green	100-109
						Spring Yellow	110-111
						Light Amber	112
						Straw	113
						Deep Amber	114
						Orange	115-116
						Light Rose	117
						English Rose	118
						Light Salmon	119
						Middle Rose	120
						Dark Pink	121-122
						Magenta	123-124
						Peacock Blue	125
						Med Blu Green	126
						Steel Blue	127
						Light Blue	128
						Dark Blue	129-130
						Leaf Green	131-133
						Dark Green	134-135
						Mauve	136-137
						Bright Pink	138-141
						Medium Blue	142-144
						Deep Golden Amber	145
						Pale Lavender	146
						Special lavender	147-148
						Primary Green	149-150
						Bright Blue	151-156
						Apricot	157-161
						Pale Gold	162-167
						Deep Orange	168-171
Bastard Amber	172-173						
Flame Red	174						
Daylight Blue	175-178						
Lilac Tint	179						
Deep lavender	180-183						
Dark Steel Blue	184-190						
Congo Blue	191-206						
Alice Blue	207						
Dirty White	208						
White	209-255						

MODE1	MODE2	MODE3	MODE4	MODE5	CHANNEL NAME	CHANNEL FUNCTION	DMX VALUE
11	11	11	11	11	Strobe	Shutter off	0-3
						Strobe-effect from slow to fast (1-25 time/S)	4-103
						Shutter open	104-107
						Opening pulse in sequences from slow to fast (0.5-25 time/S)	108-207
						Shutter open	208-212
						Random slow flash	213-225
						Random medium speed flash	226-238
						Random quick flash	239-251
12	12	12	12	12	Dimmer	Shutter open	252-255
						Dimmer 0 - 1 0 0 %	0-255
13	13	13	13	13	Dimmer Fine	Dimmer Fine	0-255
14	14	14	14	14	Pan	Pan	0-255
15	15	15	15	15	Pan Fine	Pan Fine	0-255
16	16	16	16	16	Tilt	Tilt	0-255
17	17	17	17	17	Tilt Fine	Tilt Fine	0-255
18	18	18	18	18	Function	To activate following functions, stop in DMX value for at least 5 seconds(Use of the light channel):	
						Reserved	0-11
						Pan Tilt Fast (Default)	12-24
						Pan Tilt Normal	25-37
						Dimmer Curve 1	38-42
						Dimmer Curve 2	43-47
						Dimmer Curve 3	48-52
						Dimmer Curve 4	53-57
						RGB Gamma curve(gamma=1.0)	58-62
						RGB Gamma curve(gamma=1.5)	63-67
						RGB Gamma curve(gamma=2.0)	68-72
						Activation of the following functions ninth channel linear CTO is automatically shut down	
						Halogen Lamp Simulation OFF (Default)	73-77
						Halogen Lamp Simulation,type1 (750W)	78-82
						Halogen Lamp Simulation,type2 (1000W)	83-87
						Halogen Lamp Simulation,type3 (1200W)	88-92
Halogen Lamp Simulation,type 4 (2000W)	93-97						
Halogen Lamp Simulation,type 5 (2500W)	98-102						
Reserved	103-255						

MODE1	MODE2	MODE3	MODE4	MODE5	CHANNEL NAME	CHANNEL FUNCTION	DMX VALUE
19	19	19	19	19	Reset	To activate following functions, stop in DMX value for at least 5 seconds:	
						Reserved	0–25
						Zoom reset	26–76
						Pan/Tilt reset	77–127
						Total reset	128–255
20	20	20	20	20	Zoom	Zoom in from far to near rotation can be rotated	0–52
						Zoom in from far to near rotation can not rotate	53–255
21	21	21	21	21	Zoom Rotation	0–360° Rotating optional position	0–127
						Forward rotation from slow to fast	128–190
						No rotation	191–192
						Backwards rotation from slow to fast	193–255
	22			22	Shape Selection	Reserved	0–7
						Graphics effect 1	8
						Graphics effect 2	9
						Graphics effect 3	10
						Graphics effect 4	11
						Graphics effect 5	12
						Graphics effect 6	13
						Graphics effect 7	14
						Graphics effect 8	15
						Graphics effect 9	16
						Graphics effect 10	17
						Graphics effect 11	18
						Graphics effect 12	19
						Graphics effect 13	20
						Graphics effect 14	21
						Graphics effect 15	22
						Graphics effect 16	23
						Graphics effect 17	24
						Graphics effect 18	25
						Graphics effect 19	26
						Graphics effect 20	27
						Graphics effect 21	28
						Graphics effect 22	29
						Graphics effect 23	30
						Graphics effect 24	31
						Graphics effect 25	32
Graphics effect 26	33						

MODE1	MODE2	MODE3	MODE4	MODE5	CHANNEL NAME	CHANNEL FUNCTION	DMX VALUE
	22			22	Shape Selection	Graphics effect 27	34
		Graphics effect 28	35				
		Graphics effect 29	36				
		Graphics effect 30	37				
		Graphics effect 31	38				
		Graphics effect 32	39				
		Graphics effect 33	40				
		Graphics effect 34	41				
		Graphics effect 35	42				
		Graphics effect 36	43				
		Graphics effect 37	44				
		Graphics effect 38	45				
		Graphics effect 39	46				
		Graphics effect 40	47				
		Graphics effect 41	48				
		Graphics effect 42	49				
		Graphics effect 43	50				
		Graphics effect 44	51				
		Graphics effect 45	52				
		Graphics effect 46	53				
		Graphics effect 47	54				
		Graphics effect 48	55				
		Graphics effect 49	56				
		Graphics effect 50	57				
		Graphics effect 51	58				
		Graphics effect 52	59				
		Graphics effect 53	60				
		Graphics effect 54	61				
		Graphics effect 55	62				
		Graphics effect 56	63				
		Graphics effect 57	64				
		Graphics effect 58	65				
		Graphics effect 59	66				
		Graphics effect 60	67				
	Graphics effect 61	68					
	Graphics effect 62	69					
	Graphics effect 63	70					
	Reserved	71–255					
	23			23	Shape Speed	Graphics effect cycle	0–63
		Graphics rotating counterclockwise from fast and slow	64–158				
		No rotation	159–160				
		Graphics counterclockwise rotation from slow → fast	161–255				

MODE1	MODE2	MODE3	MODE4	MODE5	CHANNEL NAME	CHANNEL FUNCTION	DMX VALUE
	24			24	Shape Fade	Shape Fade 0-100%	0-255
	25			25	Shape R	Graphics color 1 (Red)	0-255
	26			26	Shape G	Graphics color 2 (Green)	0-255
	27			27	Shape B	Graphics color 3 (Blue)	0-255
	28			28	Shape W	Graphics color 4 (White)	0-255
	29			29	Shape Dimmer	Shape Dimmer 0-100%	0-255
	30			30	Background Dimmer	Background Dimmer 0-100%	0-255
	31			31	Shape Transition	Shape Transition	0-255
	32			32	Shape Offset	Shape Offset	0-255
	33			33	Foreground Strobe	Closed	0-3
						Strobe slow →fast (1-25 flash/sec)	4-103
						Open	104-107
						Pulsation slow →fast(0.5-25 flash/sec)	108-207
						Open	208-212
						Random slow strobe	213-225
						Random medium strobe	226-238
						Random fast strobe	239-251
				Open	252-255		
	34			34	Background Strobe	Closed	0-3
						Strobe slow →fast (1-25 flash/sec)	4-103
						Open	104-107
						Pulsation slow →fast(0.5-25 flash/sec)	108-207
						Open	208-212
						Random slow strobe	213-225
						Random medium strobe	226-238
						Random fast strobe	239-251
				Open	252-255		
	35			35	Background Select	Unused range	0-7
						No selection	8
						pixe l	9
						Ring 2	10
						Ring 3	11
						Ring 4	12
						pixe l + Ring 2	13
						pixe l + Ring 2 + Ring 3	14
						pixe l + Ring 2 + Ring 3 + Ring 4	15
						Ring 2 + Ring 3 + Ring 4	16
						Ring 3 + Ring 4	17
						pixe l + Ring 4	18
						Ring 2 + Ring 3	19
						pixe l + Ring 3	20
						Ring 2 + Ring 4	21
						pixe l + Ring 3 + Ring 4	22
			pixe l + Ring 2 + Ring 4	23			
			Unused range	24-255			
		22	22	36	Red 1	Red 0-100%	0-255
		23	23	37	Green 1	Green 0-100%	0-255

MODE1	MODE2	MODE3	MODE4	MODE5	CHANNEL NAME	CHANNEL FUNCTION	DMX VALUE
		24	24	38	Blue 1	Blue 0-100%	0-255
			25		White 1	White 0-100%	0-255
		25	26	39	Red 2	Red 0-100%	0-255
		26	27	40	Green 2	Green 0-100%	0-255
		27	28	41	Blue 2	Blue 0-100%	0-255
			29		White 2	White 0-100%	0-255
		28	30	42	Red 3	Red 0-100%	0-255
		29	31	43	Green 3	Green 0-100%	0-255
		30	32	44	Blue 3	Blue 0-100%	0-255
			33		White 3	White 0-100%	0-255
		31	34	45	Red 4	Red 0-100%	0-255
		32	35	46	Green 4	Green 0-100%	0-255
		33	36	47	Blue 4	Blue 0-100%	0-255
			37		White 4	White 0-100%	0-255
		34	38	48	Red 5	Red 0-100%	0-255
		35	39	49	Green 5	Green 0-100%	0-255
		36	40	50	Blue 5	Blue 0-100%	0-255
			41		White 5	White 0-100%	0-255
		37	42	51	Red 6	Red 0-100%	0-255
		38	43	52	Green 6	Green 0-100%	0-255
		39	44	53	Blue 6	Blue 0-100%	0-255
			45		White 6	White 0-100%	0-255
		40	46	54	Red 7	Red 0-100%	0-255
		41	47	55	Green 7	Green 0-100%	0-255
		42	48	56	Blue 7	Blue 0-100%	0-255
			49		White 7	White 0-100%	0-255
		43	50	57	Red 8	Red 0-100%	0-255
		44	51	58	Green 8	Green 0-100%	0-255
		45	52	59	Blue 8	Blue 0-100%	0-255
			53		White 8	White 0-100%	0-255
		46	54	60	Red 9	Red 0-100%	0-255
		47	55	61	Green 9	Green 0-100%	0-255
		48	56	62	Blue 9	Blue 0-100%	0-255
			57		White 9	White 0-100%	0-255
		49	58	63	Red 10	Red 0-100%	0-255
		50	59	64	Green 10	Green 0-100%	0-255
		51	60	65	Blue 10	Blue 0-100%	0-255
			61		White 10	White 0-100%	0-255
		52	62	66	Red 11	Red 0-100%	0-255
		53	63	67	Green 11	Green 0-100%	0-255
		54	64	68	Blue 11	Blue 0-100%	0-255
			65		White 11	White 0-100%	0-255
		55	66	69	Red 12	Red 0-100%	0-255
		56	67	70	Green 12	Green 0-100%	0-255
		57	68	71	Blue 12	Blue 0-100%	0-255
			69		White 12	White 0-100%	0-255
		58	70	72	Red 13	Red 0-100%	0-255

MODE1	MODE2	MODE3	MODE4	MODE5	CHANNEL NAME	CHANNEL FUNCTION	DMX VALUE
		59	71	73	Green 13	Green 0-100%	0-255
		60	72	74	Blue 13	Blue 0-100%	0-255
			73		White 13	White 0-100%	0-255
		61	74	75	Red 14	Red 0-100%	0-255
		62	75	76	Green 14	Green 0-100%	0-255
		63	76	77	Blue 14	Blue 0-100%	0-255
			77		White 14	White 0-100%	0-255
		64	78	78	Red 15	Red 0-100%	0-255
		65	79	79	Green 15	Green 0-100%	0-255
		66	80	80	Blue 15	Blue 0-100%	0-255
			81		White 15	White 0-100%	0-255
		67	82	81	Red 16	Red 0-100%	0-255
		68	83	82	Green 16	Green 0-100%	0-255
		69	84	83	Blue 16	Blue 0-100%	0-255
			85		White 16	White 0-100%	0-255
		70	86	84	Red 17	Red 0-100%	0-255
		71	87	85	Green 17	Green 0-100%	0-255
		72	88	86	Blue 17	Blue 0-100%	0-255
			89		White 17	White 0-100%	0-255
		73	90	87	Red 18	Red 0-100%	0-255
		74	91	88	Green 18	Green 0-100%	0-255
		75	92	89	Blue 18	Blue 0-100%	0-255
			93		White 18	White 0-100%	0-255
		76	94	90	Red 19	Red 0-100%	0-255
		77	95	91	Green 19	Green 0-100%	0-255
		78	96	92	Blue 19	Blue 0-100%	0-255
			97		White 19	White 0-100%	0-255
		79	98	93	Red 20	Red 0-100%	0-255
		80	99	94	Green 20	Green 0-100%	0-255
		81	100	95	Blue 20	Blue 0-100%	0-255
			101		White 20	White 0-100%	0-255
		82	102	96	Red 21	Red 0-100%	0-255
		83	103	97	Green 21	Green 0-100%	0-255
		84	104	98	Blue 21	Blue 0-100%	0-255
			105		White 21	White 0-100%	0-255
		85	106	99	Red 22	Red 0-100%	0-255
		86	107	100	Green 22	Green 0-100%	0-255
		87	108	101	Blue 22	Blue 0-100%	0-255
			109		White 22	White 0-100%	0-255
		88	110	102	Red 23	Red 0-100%	0-255
		89	111	103	Green 23	Green 0-100%	0-255
		90	112	104	Blue 23	Blue 0-100%	0-255
			113		White 23	White 0-100%	0-255
		91	114	105	Red 24	Red 0-100%	0-255
		92	115	106	Green 24	Green 0-100%	0-255
		93	116	107	Blue 24	Blue 0-100%	0-255

MODE1	MODE2	MODE3	MODE4	MODE5	CHANNEL NAME	CHANNEL FUNCTION	DMX VALUE
			117		White 24	White 0-100%	0-255
	94	118	108		Red 25	Red 0-100%	0-255
	95	119	109		Green 25	Green 0-100%	0-255
	96	120	110		Blue 25	Blue 0-100%	0-255
		121			White 25	White 0-100%	0-255
	97	122	111		Red 26	Red 0-100%	0-255
	98	123	112		Green 26	Green 0-100%	0-255
	99	124	113		Blue 26	Blue 0-100%	0-255
		125			White 26	White 0-100%	0-255
	100	126	114		Red 27	Red 0-100%	0-255
	101	127	115		Green 27	Green 0-100%	0-255
	102	128	116		Blue 27	Blue 0-100%	0-255
		129			White 27	White 0-100%	0-255
	103	130	117		Red 28	Red 0-100%	0-255
	104	131	118		Green 28	Green 0-100%	0-255
	105	132	119		Blue 28	Blue 0-100%	0-255
		133			White 28	White 0-100%	0-255
	106	134	120		Red 29	Red 0-100%	0-255
	107	135	121		Green 29	Green 0-100%	0-255
	108	136	122		Blue 29	Blue 0-100%	0-255
		137			White 29	White 0-100%	0-255
	109	138	123		Red 30	Red 0-100%	0-255
	110	139	124		Green 30	Green 0-100%	0-255
	111	140	125		Blue 30	Blue 0-100%	0-255
		141			White 30	White 0-100%	0-255
	112	142	126		Red 31	Red 0-100%	0-255
	113	143	127		Green 31	Green 0-100%	0-255
	114	144	128		Blue 31	Blue 0-100%	0-255
		145			White 31	White 0-100%	0-255
	115	146	129		Red 32	Red 0-100%	0-255
	116	147	130		Green 32	Green 0-100%	0-255
	117	148	131		Blue 32	Blue 0-100%	0-255
		149			White 32	White 0-100%	0-255
	118	150	132		Red 33	Red 0-100%	0-255
	119	151	133		Green 33	Green 0-100%	0-255
	120	152	134		Blue 33	Blue 0-100%	0-255
		153			White 33	White 0-100%	0-255
	121	154	135		Red 34	Red 0-100%	0-255
	122	155	136		Green 34	Green 0-100%	0-255
	123	156	137		Blue 34	Blue 0-100%	0-255
		157			White 34	White 0-100%	0-255
	124	158	138		Red 35	Red 0-100%	0-255
	125	159	139		Green 35	Green 0-100%	0-255
	126	160	140		Blue 35	Blue 0-100%	0-255
		161			White 35	White 0-100%	0-255
	127	162	141		Red 36	Red 0-100%	0-255
	128	163	142		Green 36	Green 0-100%	0-255
	129	164	143		Blue 36	Blue 0-100%	0-255
		165			White 36	White 0-100%	0-255
	130	166	144		Red 37	Red 0-100%	0-255
	131	167	145		Green 37	Green 0-100%	0-255
	132	168	146		Blue 37	Blue 0-100%	0-255
		169			White 37	White 0-100%	0-255

8.2 Multivariate model(B mode)

BASIC ENGINE			
STANDARD		SHAPES	
CHAN- NEL	CHANNEL MODE	CHAN- NEL	CHANNEL MODE
1	Red	1	Red
2	Red fine	2	Red fine
3	Green	3	Green
4	Green fine	4	Green fine
5	Blue	5	Blue
6	Blue fine	6	Blue fine
7	White	7	White
8	White fine	8	White fine
9	Linear CTO	9	Linear CTO
10	Macro colour	10	Macro colour
11	Strobe	11	Strobe
12	Dimmer	12	Dimmer
13	Dimmer Fine	13	Dimmer Fine
14	Pan	14	Pan
15	Pan Fine	15	Pan Fine
16	Tilt	16	Tilt
17	Tilt Fine	17	Tilt Fine
18	Function	18	Function
19	Reset	19	Reset
20	Zoom	20	Zoom
21	Zoom Rotation	21	Zoom Rotation
		22	Shape Selection
		23	Shape Speed
		24	Shape Fade
		25	Shape R
		26	Shape G
		27	Shape B
		28	Shape W
		29	Shape Dimmer
		30	Background Dimmer
		31	Shape Transition
		32	Shape Offset
		33	Foreground Strobe
		34	Background Strobe
		35	Background Select

PIXEL ENGINE			
RGB		RGBW	
CHAN- NEL	CHANNEL MODE	CHAN- NEL	CHANNEL MODE
1	Red LED 1	1	Red LED 1
2	Green LED 1	2	Green LED 1
3	Blue LED 1	3	Blue LED 1
...	RedLED ...	4	White LED 1
...	Green LED	RedLED ...
...	Blue LED	Green LED ...
109	Red LED 37	...	Blue LED ...
110	Green LED 37	...	White LED ...
111	Blue LED 37	145	Red LED 37
		146	Green LED 37
		147	Blue LED 37
		148	White LED 37

Pixel Engine need to be enabled through the function channel.

NOTE: On conclusion of resetting in case of absence of DMX signal, Pan & Tilt move to the "Home" position (Pan 128 bit - Tilt 128 bit) all the others channels stay at 0 bit.

MACRO COLOUR

S/N	DMX VALUE	CHANNEL FUNCTION	BIT VALUE			
			R	G	B	W
1	0-9	Reserved	0	0	0	0
2	10	Red	255	0	0	0
3	11	Green	0	255	0	0
4	12	Blue	0	0	255	0
5	13	Cyan	0	255	255	0
6	14	Yellow	216	255	0	0
7	15	Magenta	255	0	160	0
8	16	White 7000 K	164	255	18	255
9	17	White 3700 K	255	255	57	0
10	18	White 5000 K	255	137	0	176
11	19	Black	0	0	0	0
12	20-22	Medium Yellow	207	126	0	0
13	23-26	Straw Tint	152	84	1	0
14	27-28	Surprise Peach	238	84	1	0
15	29	Fire	246	14	0	0
16	30	Medium Amber	246	72	0	0
17	31	Gold Amber	246	48	0	0
18	32-34	Dark Amber	246	22	0	0
19	35-44	Sunrise Red	246	34	0	0
20	45	Medium Pink	246	61	0	96
21	46-48	Medium Pink	255	46	0	56
22	49-61	Pink Carnation	255	63	0	94
23	62-67	Light Lavender	212	47	0	227
24	68-77	Lavender	212	41	22	255
25	78-88	Sky Blue	0	255	46	0
26	89-99	Just Blue	0	137	46	0
27	100-109	Dark yellow green	21	255	0	0
28	110-111	Spring Yellow	255	178	0	0
29	112	Light Amber	214	108	0	0
30	113	Straw	210	105	0	51
31	114	Deep Amber	255	130	0	3
32	115-116	Orange	255	80	0	0
33	117	Light Rose	255	106	0	11
34	118	English Rose	255	100	2	0
35	119	Light Salmon	255	77	3	7
36	120	Middle Rose	255	60	1	0
37	121-122	Dark Pink	253	39	3	0
38	123-124	Magenta	255	0	1	0
39	125	Peacock Blue	0	255	0	23
40	126	Med Blu Green	157	255	0	23
41	127	Steel Blue	0	7	255	0
42	128	Light Blue	0	255	4	23
43	129-130	Dark Blue	0	91	255	0
44	131-133	Leaf Green	167	255	0	0
45	134-135	Dark Green	11	255	2	0
46	136-137	Mauve	255	0	6	0
47	138-141	Bright Pink	255	6	2	0
48	142-144	Medium Blue	0	255	34	0
49	145	Deep Golden Amber	255	17	0	0
50	146	Pale Lavender	228	116	6	0
51	147-148	Special lavender	171	116	6	8
52	149-150	Primary Green	15	255	0	0
53	151-156	Bright Blue	0	255	14	0
54	157-161	Apricot	212	54	0	0
55	162-167	Pale Gold	248	94	2	0
56	168-171	Deep Orange	255	22	0	0
57	172-173	Bastard Amber	255	108	1	0
58	174	Flame Red	255	4	0	0
59	175-178	Daylight Blue	17	255	16	0
60	179	Lilac Tint	255	129	0	14
61	180-183	Deep lavender	255	75	0	28
62	184-190	Dark Steel Blue	66	182	0	53
63	191-206	Congo Blue	25	0	255	0
64	207	Alice Blue	49	255	30	0
65	208	Dirty White	255	255	20	255
66	209-255	White	255	255	13	255

✦ RED
GREEN
BLUE
WHITE



UVALUE	EFFECT
255	LED ON
0	LED OFF

✦ RED FINE
GREEN FINE
BLUE FINE
WHITE FINE



UVALUE	EFFECT
255	UP
0	LOW

✦ LINEAR CTO

UVALUE	EFFECT
255	2500K
...	...
224	3200K
...	...
188	4000K
...	...
144	5000K
...	...
117	5600K
...	...
99	6000K
...	...
54	7000K
...	...
10	8000K
0-9	未使用的范围

Note: If CTO channel is active, the white channel is disabled.

Function

CHANNEL FUNCTION	DMX VALUE
To activate following functions, stop in DMX value for at least 5 seconds(Use of the light channel):	
Reserved	0-11
Pan Tilt Fast (Default)	12-24
Pan Tilt Normal	25-37
Dimmer Curve 1	38-42
Dimmer Curve 2	43-47
Dimmer Curve 3	48-52
Dimmer Curve 4	53-57
RGB Gamma curve(gamma=1.0)	58-62
RGB Gamma curve(gamma=1.5)	63-67
RGB Gamma curve(gamma=2.0)	68-72
Activation of the following functions ninth channel linear CTO is automatically shut down	
Halogen Lamp Simulation OFF (Default)	73-77
Halogen Lamp Simulation,type1 (750W)	78-82
Halogen Lamp Simulation,type2 (1000W)	83-87
Halogen Lamp Simulation,type3 (1200W)	88-92
Halogen Lamp Simulation,type 4 (2000W)	93-97
Halogen Lamp Simulation,type 5 (2500W)	98-102
Reserved	103-255

DIMMER CURVE 1 - GAMMA 1 LINEAR

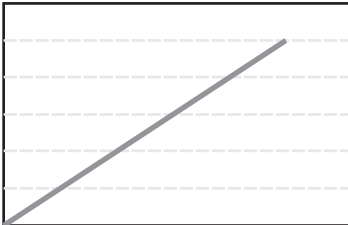

DIMMER CURVE 2 - GAMMA 1,5

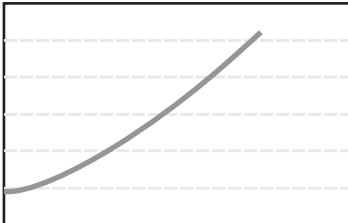

DIMMER CURVE 3 - GAMMA 2,0

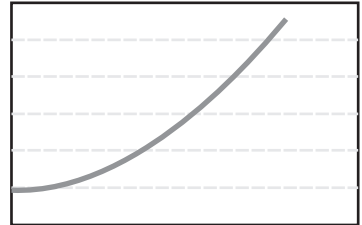

DIMMER CURVE 4 - S

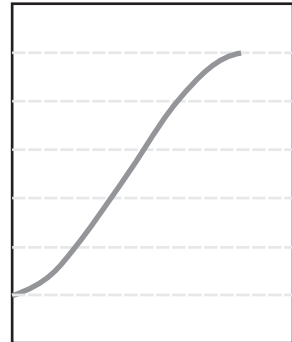

LED reference number for pixel mapping

TILT: channel 16 @ 200 bit

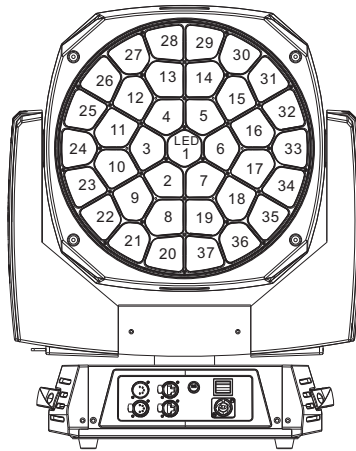

9. Maintenance and cleaning

DANGER: Disconnect from the mains before starting any maintenance work.

It is absolutely essential that the fixture is kept clean and that dust, dirt and smoke fluid residues must not build up on or within the fixture. Otherwise, the fixtures light-output will be significantly reduced. Regular cleaning will not only ensure the maximum light-output, but will also allow the fixture to function reliably through out its life. A soft lint-free cloth moistened with any good glass cleaning fluid is recommended, under no circumstances should alcohol or solvents be used!

The front objective lens will require weekly cleaning as smoke-fluid tends to building up residues, reducing the light-output very quickly. The cooling-fans should be cleaned monthly.

The gobos may be cleaned with a soft brush, The interior of the fixture should be cleaned at least annually using a vacuum-cleaner or an air-jet.

There are no serviceable parts inside the device except for the lamp and the fuse.

Replacing the fuse: If the lamp burns out, the fine-wire fuse of the device might fuse, too. Only replace the fuse by a fuse of same type and rating. Before replacing the fuse, unplug mains lead.

Maintenance and maintenance of the operation, please contact the manufacturer or distributor.

10. Electric equipment specification

10.1 Electrical parameters

SOURCE: RGBW LED-15W

POWER: 750W

VOLTAGE: AC100-240V 50/60HZ

Color Temperature: 6500K

10.2 Weight and dimensions

Dimensions : 463.5X287X580mm

NET WEIGHT: 22Kg

Dimensions (Carton Package) : 596X491X656mm

WEIGHT (Carton Package) : 28Kg

Dimensions (Flight Case -2 lights): 805X525X815mm

NET WEIGHT/WEIGHT (Flight Case -2 lights) : 36Kg/61Kg

10.3 Channel Characteristics

1. 21、35、132、169、146 five standard DMX channel model or 21、35 two standard DMX channel model and network control mode optional.

2. Scan: Pan540° , Tilt210° , Fixture could auto reset.

3. Dimmer: linear dimmer.

4. Zoom: linear amplifier.

5. Enlarged rotation: Can be 360° degrees clockwise, counterclockwise rotation.

6. 37 RGBW lamp can be controlled separately.

7. The network control mode and DMX control mode have independent control and combined control.

8. Shutter: electronic shutter, random strobe.

10.4 Menu Function

1. Touch screen, English menu.
2. DMX values and communication quality values can be displayed in each channel. .
3. Monitor could ON/OFF automatically.
4. Show fixture use time.
5. After the DMX signal is disconnected, the display will be bright and dark.
6. The screen can be set automatically to flip or hand over.
7. Auto error detection.
8. Wireless input, wired input, wireless in/xlr out, ETHNET input.
9. With DMX software upgrade.
10. 5 seconds after the DMX signal is disconnected, the amplification is automatically retracted.

10.5 light table

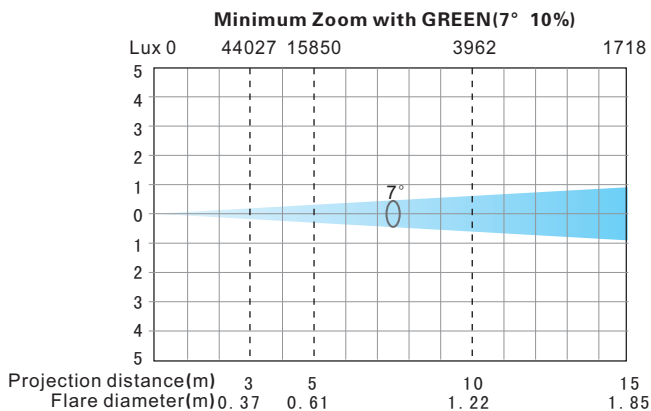
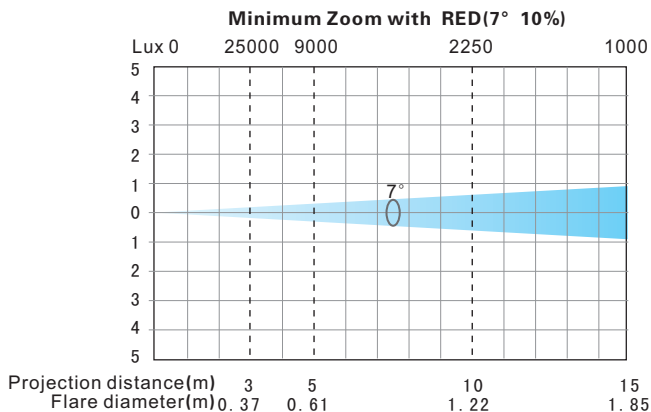

Minimum Zoom with BLUE(7° 10%)

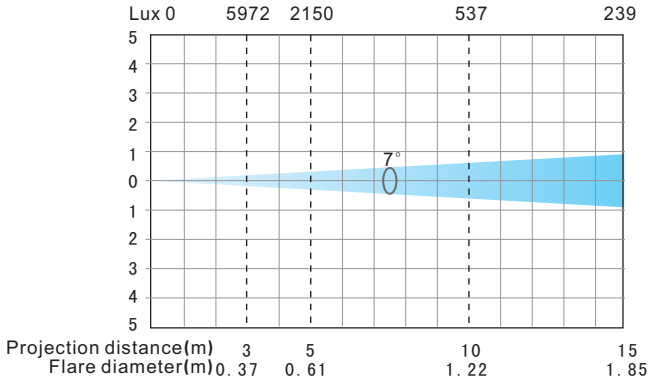

Minimum Zoom with WHITE(7° 10%)

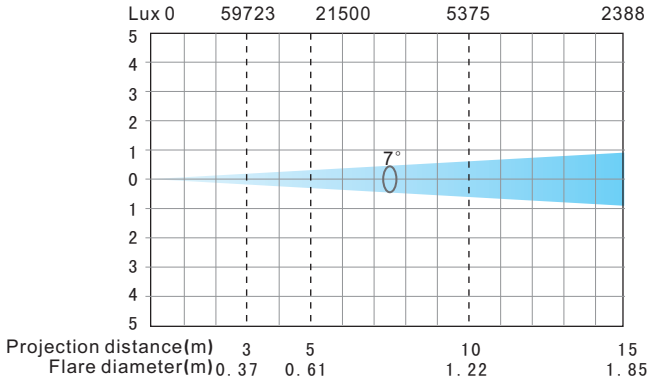

Minimum Zoom with WHITE,RED,GREEN&BLUE(7° 10%)

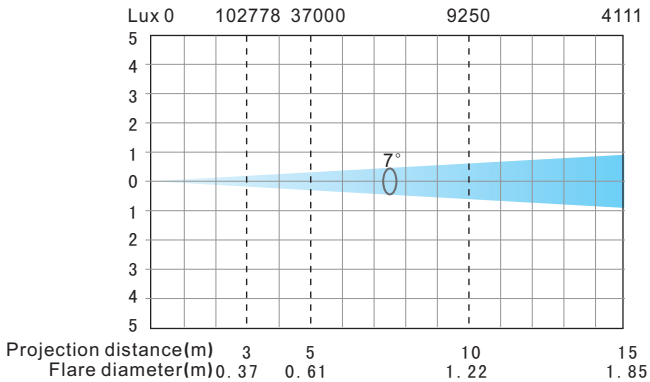

Maximum Zoom with RED(60° 10%)

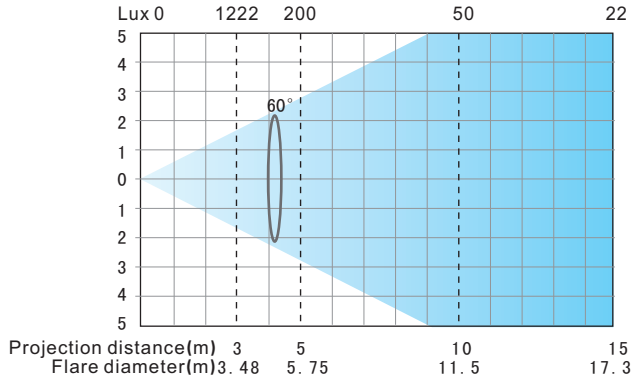

Maximum Zoom with GREEN(60° 10%)

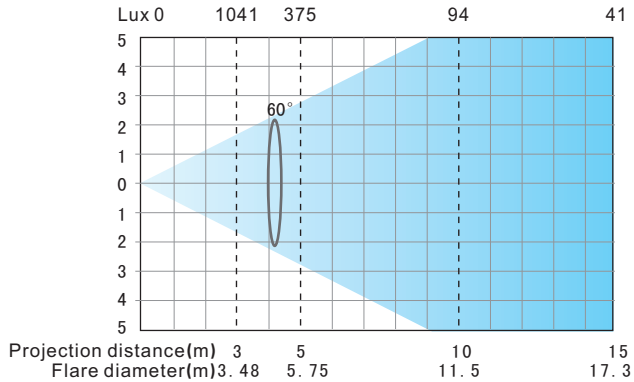

Maximum Zoom with BLUE(60° 10%)

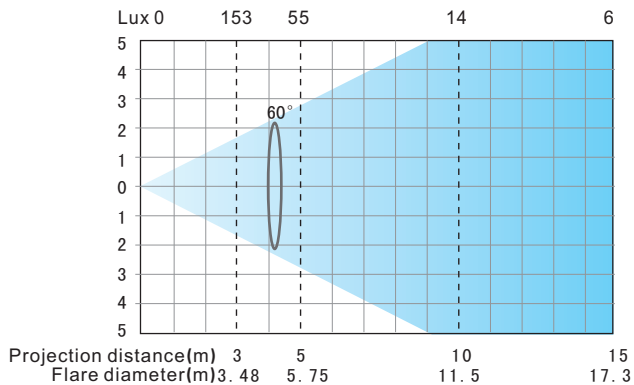

Maximum Zoom with WHITE(60° 10%)

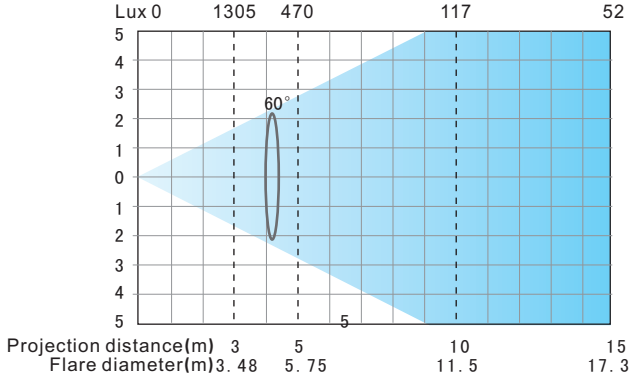

Maximum Zoom with WHITE,RED,GREEN&BLUE(60° 10%)

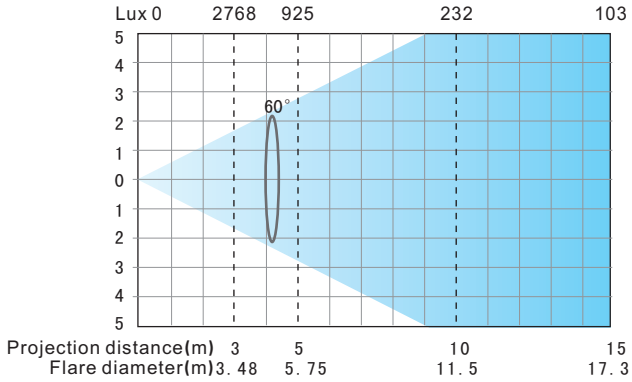

11. Electronic drawing

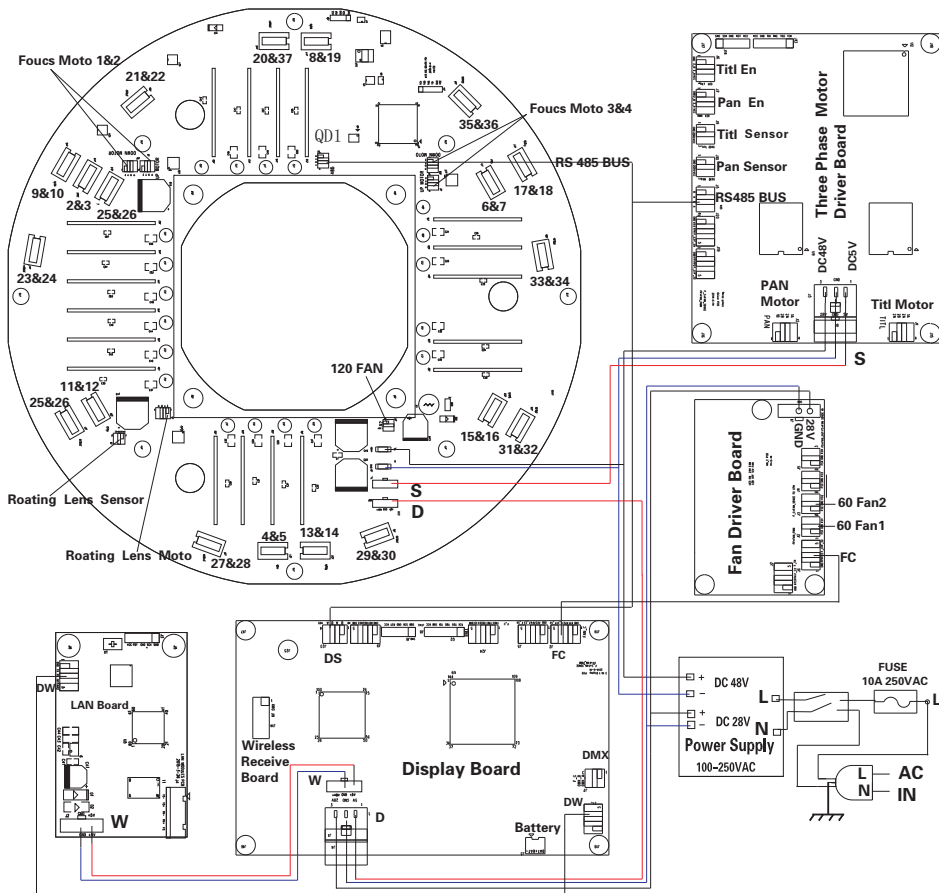

Note: The above contents for reference only and is subject to change without prior notice, please take specification you have on hand and our company reserves the final right of interpretation.



<http://www.jollylighting.com>

Guangzhou hongcai stage equipment Co.,Ltd

Tel:+862084558833 Fax:+862084559699

Email:info@jollylighting.com P.C:511450

Add:Building2,No.32,Changsha Street, Shachong Village,shiji Tow.Panyu District,Guangzhou,China